

Student Energy Efficiency Mini Grants

by Beth Otto

Would you like to empower your students to save energy at school? Maine DEP and MEEP are offering student mini grants again this year. These grants are meant to supplement a student energy efficiency investigation of the school. Students can apply for money to help to fund their recommendations to save energy. Borrow a toolkit from MEEP to start assessing the energy use of your school!

Last year, 11 student projects were funded in amounts ranging from \$100 to \$1,000. DEP and MEEP focused on projects that would bring energy awareness to other students and promote long term behavior changes.

Here's a glimpse into some of last year's projects:

- One group of students provided **task lighting** (desk lamps) for teachers so that overhead lights could be turned off more regularly.
- Another group installed energy efficient **LED exit signs**.
- Some students applied **weather stripping** around the school with

their facility manager.

- Other groups purchased **timers** for their laptop charging stations and **occupancy sensors** for bathrooms.
- One group replaced paper towels with high efficiency (and high visibility) **hand dryers**.

To apply for a grant, check out our website (www.mEEPnews.org), and click on the Mini Grants tab. Students will need to fill out the grant proposal, which must be accompanied by a report, detailing the analysis leading up to their grant proposal. MEEP is here to help you through the process, so don't hesitate to ask! 🌍

The April 11th deadline is fast approaching! Call Beth today to get started on your School Energy Efficiency Investigation!

School Gardens and Energy

by Stefany Gregoire

In the fall of 2009, teacher Melissa Storey invited MEEP to River View Community School to do our My Light lesson with all of the third graders. River View serves all 3rd-5th grade students who live in the town of Gardiner.

At the same time, I was getting involved with a local project called **Caring Community Gardens**. The mission: to provide fresh, organic, local produce to the food pantry in Gardiner. The challenge: funding! I was busy applying for grants – some of which seemed like very long shots. One grant, from Fiskars Orange Thumb, aimed to fund projects that involved gardening and education. I immediately contacted Melissa, who recruited 5th grade teacher Meggan Henerlau to join our efforts.

Planning the River View garden project was a leap of faith, since we had no funding. But how could we turn down the free plot of land next to the school or ignore the enthusiasm of the teachers? Fortunately, MEEP's supportive Board of Directors agreed to allow me to use my time working on the project, provided that we weaved in energy efficiency connections.

The plan was for Mike McGlenn,

(MEEP's AmeriCorps Volunteer) and me to visit RVCS weekly, working on projects such as starting seedlings and learning about plants. Using ideas from [Green Teacher Magazine](#) and the [What's on Your Plate?](#) curriculum, we also included topics such as:

- **Food Production** – The students acted out the steps that go into getting an apple to the consumer: water, fertilizers & pesticides, harvesting, sorting, cleaning, packing,

continued on page 2



Mrs. Storey's class was partly responsible for providing all this squash to families in need.

Table of Contents

| | |
|---------|--|
| P. 2 | <i>Air Source (Not Ground Source) Heat Pumps</i> |
| P. 3 | <i>Building Skills (and an Efficient House) in Westbrook</i> |
| Pp. 4-5 | <i>Activity: Composting</i> |
| P. 6 | <i>MEEP's New Carbon Cycle Game</i> |
| P. 7 | <i>Willard School's Single-Sex Classrooms</i> |



GREEN SCHOOLS NEWS

is a collaboration between the Air Quality Bureau of the Maine Department of Environmental Protection and Maine Energy Education Program. This edition compiled by Stefany Gregoire.

MEEP

PO Box 728
Parsonsfield, ME 04047
207-625-7833
www.meepnews.org

Staff:

- Peter Zack, Director
- Stefany Gregoire, Asst. Director
- Beth Otto, Carbon Footprint Educator
- Mike McGlenn, AmeriCorps
- Angela Ferrelli, AmeriCorps

Maine Energy Education Program is sponsored by:



About Air Source (Not Ground Source) Heat Pumps

by Peter Zack

Our friend Jack Bash of Cornish recently purchased an air source heat pump. He and his wife displayed it as part of MEEP's Sacopee Valley Green Energy Open House in October. We asked Jack to tell us about it.

GSN: Can you explain for our readers how an air source heat pump works?

Bash: A heat pump works just like an air conditioner, only in reverse. It draws the warm air from the outside and delivers it to the house, where an air conditioner removes the hot air from your house, replacing it with cool air. The unit I have is both an air conditioner and heat pump, providing cool air in the summer and warm air in the heating months. It is set to deliver heat into the house through the furnace and a forced air system with ducting when the thermostat calls for heat. It will continue to deliver heat until the outside temperature drops to 25 degrees (F), then the regular oil furnace kicks in.

GSN: How much did the system cost, and how long do you think the pay-back period will be?

Bash: The cost was about \$5,000. We wanted an air conditioner and that would have been \$4,000. By adding the heat pump feature it added another \$1,000. I hope to save 300-400 gallons of heating oil, or about \$900-\$1,200 per year, less the added cost of electricity. This would pay off the heat pump add-on in just over a year, and the entire system in about six years. Of course if the price of oil goes up, the payoff is shorter...Saving money was, of course, a major reason for installing the heat pump, but reducing my reliance on oil is very important to me.

Fact: For each unit of electrical energy you put into a heat pump, you get up to four units of heat energy!

Editor's note: Here at MEEP, we think it is important to present the pros and cons of using various energy sources. In that light, we'd like to take a second look at air source heat pump technology.

continued on page 6

Gardening

continued from page 1

- shipping, storage...
- **Land use** – Using an apple, we helped the students visualize just how little land on earth is suitable for growing food. To see the activity, search for "The World in an Apple" at www.greenteacher.com.
 - **Food miles** – The students learned the importance of being "locavores" after examining how far the parts of their school lunch traveled to get to their lunchroom trays. This activity is a modified version of "Long Distance Mapping" from whatsonyourplateproject.com.

In March, word that we would re-

ceive funding from Fiskars! The grant included \$1,000 in garden tools and a \$1,000 gift card from a local home & garden store. The support has gone a long way to help our little gardens grow.

The River View students planted their hearty seedlings in June, and in October they harvested 371 pounds of winter squash! The students were excited to provide all that fresh, local produce to the food pantry. This spring, the cycle will begin again, with new students and a composting and vermiculture component from DEP's AmeriCorps Volunteer Angela Ferrelli. 🌍

Building Skills (and an Efficient House) in Westbrook

by Mike McGlenn

On a cold, blustery winter afternoon, Westbrook Regional Vocational High School students are hard at work on the jobsite. They are constructing an energy efficient ranch-style house that is funded by the Rotary Club of Westbrook-Gorham. Thomas Pitman and Kirk Nygren lead the young workers as they integrate old and new construction trends into this home, which will eventually be sold on the market. Along with traditional building skills, the students are also learning greener design methods. This working classroom is the first of four to be built in the coming years.

The vocational students are the epicenter of this venture as they continue to help in nearly all facets of the project. Even before groundbreaking and permits, advanced senior students sat on the design board. Students broke down into teams, each focusing on their own discipline. These workers collectively accomplished the architectural drafting, excavation, framing, insulation, and electrical work. The community also provided much support. The financial investment provided by the local Rotary Club benefits the community by giving the students a working classroom. The local heavy equipment dealer graciously lent earth movers and other equipment to support the project.

In green building, one doesn't usually choose the words "ranch" and "efficient" in the same sentence. Because



The students insulated the basement floor.

their floor plans are spread out, ranches have difficulty retaining heat. To combat this stereotype, the students are super-insulating and sealing the house to prevent heat exchange.

Moisture is a concern when building a house in the northeast, especially when a basement is involved. Humidity encourages mold growth, thereby diminishing indoor air quality. Before installing the foundation, the students lined the footprint with a vapor barrier, preventing wetness in the cellar. Then they coated the exterior walls with a vapor barrier. This feature keeps the house dry and stops potential air leaks. An interior ceiling vapor barrier locks the seal resulting in a dry and mold free interior.

Installing air vapor barriers works in theory, but only if it's tightly sealed. The students will conduct two blower door tests to expose any existing air leaks. Experts and contractors in training (students) will then locate the drafty areas and plug accordingly. To ensure the tightness of the seal, electrical students took care to re-seal the holes cut out for appliances and electrical outlets. Windows and their frames are often the culprits of air leaks so the students heavily sealed the window frames.

Although a vapor barrier works well to prevent heat loss, it can have a negative effect on air quality. A building that is sealed too well can have problems with backdrafting of combustion appliances and mold growth. To prevent these issues, an energy ventilation recovery system will be installed.

Conduction is another way heat moves in and out of the house. To combat this, the students will continue to heavily insulate the house. The basement cement is insulated to prevent heat exchange between the 52-degree earth and room temperature interior. The finished walls will appear normal, but each utilizes double thick construction, a feature where two walls are sandwiched together with a staggered framing pattern. The staggered walls will be



Exterior of the Westbrook house.

filled with high R-value insulation. This double-walled construction provides a thermal barrier from the great outdoors.

All of these energy saving features add to the total construction cost. However, this cost will be offset by an increased market value because of a lessened utility cost to the future homeowner. The project cost is estimated at \$130 per square foot. The profits will be used to build the next home. The four homes will aesthetically fit within the existing sub-division community.

With a background in Environmental Science and Construction, Mr. Pitman mentions he would have ideally utilized a solar array in this project. As all practical environmentalists agree, mediating between deep green practices, the short-term return on investment, and the conventional way of thinking is seldom easy. Therefore, the design team chose to use an efficient propane heating system. The team of student electricians did a wonderful job of installing energy efficient lighting. In our complex world efficiency is just as important as alternative energy. This house practices the mantra of efficiency before alternatives. 🌍

Activity: Composting

by Angela Ferrelli



Level

Grades 3-12

Subjects

Earth Science, Biology, Ecology

Concepts

By reducing waste and recycling/composting materials, individuals and societies can help to reduce their impact on energy consumption, land use, and air quality.

Skills

- Classifying
- Designing
- Decision-making
- Group cooperation
- Critical thinking

Materials

For Game:

- Bags of “trash” (keep in mind that the students will be handling the trash)
- Rubber gloves

For Design Activity:

- Paper
- Colored pencils or markers

For Research:

- Copies of worksheet, page 5

Additional materials needed for extension activities.

Time Considerations

- Two 50 minute class periods (longer if students are doing research in class)
- Extension activities involve longer-term projects.

Resources

- A great resource for recycling, composting, and waste management: www.calrecycle.ca.gov/Education/Curriculum/
- Florida’s composting center: www.compostinfo.com

Overview

In this lesson, students learn the basics of composting and how it can help reduce energy consumption related to waste management. Between 60 and 70 percent of household solid waste can be composted and turned into soil. This lesson includes a hands-on activity that keeps students engaged with the material they are learning. An additional research component is suggested for older students.

Composting uses the natural process of decomposition to break down organic wastes into fertile soil. The key to successful composting is the ratio of “brown” carbon-rich to “green” nitrogen-rich materials you put in the compost. The decomposers (microorganisms & invertebrates) that break down the organic material need carbon for energy and nitrogen for growth. Add water and good air flow, and you have compost!

Air + Water + Carbon + Nitrogen = Compost

Maintaining a good nutrient balance, appropriate particle size, moisture content, and a good oxygen flow will all help to reduce the odors produced by the composting process through optimal microbial activity.

Getting Ready

Research the composting resources at left to familiarize yourself with composting. It may be helpful to use the worksheet on page 5 for important points. Gather materials for the activities below and make copies of the worksheet if your students will be doing their own research.

Doing the Activity

INTRODUCTION: Brainstorm what students know about composting. Do any of them compost at home?

HOW IT WORKS: The students depict composting using a concept map or other similar method. Ask them to identify our decomposing friends. (Bacteria, fungi, bugs and earthworms). What are some different ways to make compost? (Bin, tumbler, vermiculture, etc.) Is there a magic formula for compost? (The right mix of “brown” carbon and “green” nitrogen speeds up decomposition). What else must we consider to keep our compost healthy? (Air flow, moisture, temperature, particle size). You can use the worksheet on page 5 for more questions or to guide your students in research.

GAME: In groups, the students sort through a bag of “trash” to separate the materials into three categories: compost, recycle, trash. Ask them to consider ways to reduce the waste stream.

DESIGN A COMPOST SYSTEM: Students work in small groups to draw a design of an ideal composting system. They need to decide which method of composting they will use, who is going to be using this system, and what organic material will be included in the compost. Each group shares their design with the class.

PROS, CONS, SOLUTIONS: Discuss benefits and drawbacks of composting and how to combat issues that can arise from a compost pile.

Extensions

- Vermicomposting: make a worm bin for your classroom. www.calrecycle.ca.gov/Education/Curriculum/Worms/default.htm
- Soda Bottle Composting Systems make great hands-on experience. www.composterconnection.com/site/micro-composting.html

Get the "Dirt" on Composting

1. What materials can be composted?

2. Circle the materials should not be composted.

- | | | |
|------------|-------------|----------------|
| Apple Core | Meat Scraps | Stale Bread |
| Old Cheese | Mushrooms | Bones |
| Pet Waste | Straw | Coffee Grounds |
| Nut Shells | Tissues | Cow Manure |

Why shouldn't we put them in the compost?

3. Name at least one type of organism that helps to break down compost.

4. Compostable materials are considered either "Green" or "Brown". Explain the difference between the two.

5. Label each of the following materials as "Green" or "Brown":

- | | | |
|------------|-----------------|-------------|
| Apple Core | Twigs | Stale Bread |
| Tea Bag | Corn Stalk | Dryer Lint |
| Sawdust | Grass Clippings | Hair |

6. Match each composting method listed with its picture below.

- Windrow
- Vermiculture
- Tumbler
- Bin
- In vessel

Method: _____

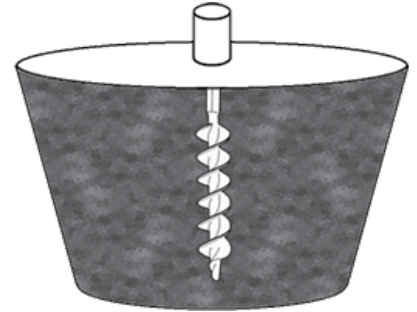

Method: _____

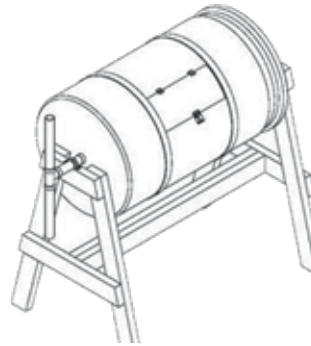

Method: _____



Method: _____

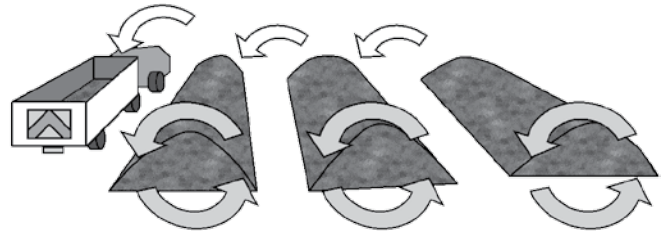

Method: _____



MEEP's New Carbon Cycle Game

by Mike McGlinn

Carbon is vitally important to many processes here on Earth. Science textbooks call all life on the planet "carbon-based organisms." This element has been described as the backbone of all living things. Even young students know the simple fact that plants need it to survive and animals breathe it out each time they exhale. It is an essential part of our atmosphere, keeping the climate here mild. Yet, most of the carbon in the world is locked up in rocks or the ocean. It can be hard to understand how carbon moves about the planet. Therefore, MEEP decided to make a fun and interactive board game as our educational tool.

What does carbon have to do with Energy? Because they were formed from organisms living millions of years ago, coal, petroleum and natural gas are named the **fossil fuels**. Humans extract

these sources of energy and burn them for electricity, heating, transportation and manufacturing. In the process we release carbon into the atmosphere.

Any 4th grader may wonder, "plants need it to breathe so what's the big deal?" We'll I'm glad you asked! Scien-

tists tell us that man's carbon emissions are the leading culprit in **climate change** and the process known as **ocean acidification**. This game helps to clarify how carbon moves about the planet, its role in each process and the ramifications of increased carbon emissions.

In the game, students travel through the carbon cycle, learning facts along the way. Round one portrays the balanced carbon cycle as it was just before the industrial revolution. In this round, some students might get stuck as a fossil fuel, locked away until the next round. In round two, students learn the effects of adding carbon to the atmosphere. In the final round, students use what they've learned and must come up with ways they can change their actions to stop the increase in carbon emissions. 🌍

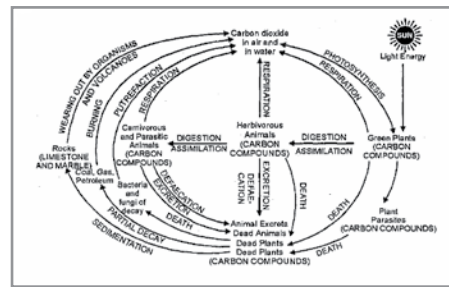

The carbon cycle is usually depicted with complicated diagrams like this. Mike from MEEP has worked to demystify the carbon cycle.

Air Source Heat Pumps

continued from page 2

Advantages:

- Heat pumps are typically 60-75% more efficient than other electric heaters.
- They require less maintenance than more common heating systems.
- There is no combustion involved.
- They can also be used for cooling.

Disadvantages:

- Heat pumps require electricity, which may come from burning fossil fuels.
- The condensers require space outdoors and can be noisy when operating.
- They can be expensive to install.

It's important to consider the pros and cons of an investment! 🌍

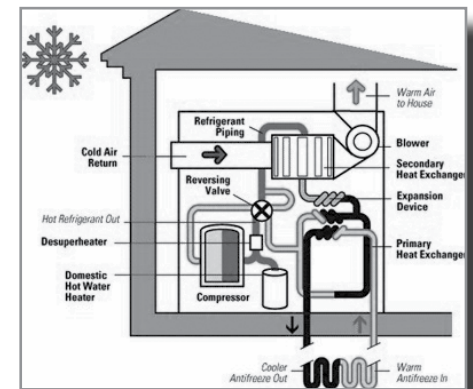

A heat pump can act as an air conditioner in the summer and a heater in colder months.

Contact MEEP

Scheduling Classroom Visits in Southern & Western Maine:

Peter Zack, Director
peter@meepnews.org
207-625-7833

Scheduling Classroom Visits in all other regions:

Stefany Arsenault, Assistant Director
stefany@meepnews.org
207-287-4855

Mike McGlinn, MEEP AmeriCorps
mike@meepnews.org
207-287-6779

Beth Otto, Carbon Footprint Educator
beth.otto@maine.gov
207-287-6096

Angela Ferrelli, DEP AmeriCorps
angela.ferrelli@maine.gov
207-287-7027

Visit us online! • WWW.MEEPNEWS.ORG • Find us on Facebook, too!

There's Something Happening Here (Part II): Willard School's Single-Sex Classrooms

by Peter Zack

Our last issue of Green Schools News (GSN) reported that Willard School in Sanford had completed Year One of a two year experiment featuring the voluntary gender separation of some of its sixth grade students. To read the article, visit www.meeppnews.org and click on "Green Schools News."

This January, GSN visited with Principal Chuck Potter, who shared quantitative data from the experiment's maiden year. Discipline referrals for both gender populations dropped (Fig. 1). Improved academic performance was not a stated goal of the experiment, but the Northwest Educational Assessment (NWEA) results were encouraging (Fig. 2).

Attendance data seemed counter-intuitive. Excused and unexcused absences rose for both classes. Absences for the boys rose from 78 to 121, while the girls missed 214 days up from 206 in the previous year. The teachers—Tracie Wagenfeld (boys) and Barbara Noone (girls)—offer the caveat that extended sicknesses and extenuating family circumstances may have skewed the data. Potter intends to examine attendance records for all eight sixth grade classes last year to see if any pattern exists.

As this is being written, Year Two is half over. Both Wagenfeld and Noone have larger (23 students each) and more diverse groups this year. Each contin-

Fig 1: Disciplinary Referrals

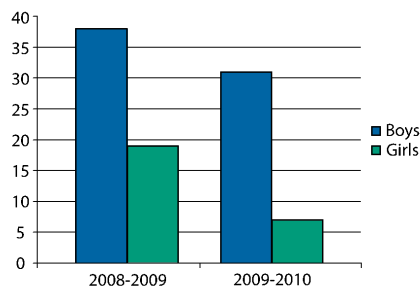

Seven boys and five girls visited the Principal's office less than the year before the experiment. Only three boys visited Mr. Potter more.

ues to be enthusiastic about the experiment. "What's not to like about teaching 23 girls?" asks Noone... "This program works. It gives children an opportunity to grow as people within a supportive network. They aren't all best friends, but they realize that this opportunity is much bigger than just themselves."

"I can't wait to see what happens in the future with the program!" says Wagenfeld, who praises the support of parents. "They are quick to send in snacks for (the) boys, purchase fitness equipment for the fitness center, or just volunteer their time for activities during and after school." She has already heard from parents looking for their kids to participate in the program next year.

The students appear similarly upbeat. They use the terms "proud" and "privileged" to describe their feelings about the experiment. The girls shared with GSN some of the advantages of their single gender class: "We talk about things more." "We can share more without boys interrupting." "There's less social drama." "You can be yourself."

Some insights are poignant: "You see sides of people you haven't seen before." "We've become a family."

From the boys: "We need more physical activity (than girls)." Wagenfeld provides 'motor breaks' every 30 minutes or so, either in the class fitness center (juggling, jumping rope), or outside walking laps on the playground. Offers Wagenfeld: "They have become energized and enthusiastic after their break and can concentrate more efficiently." She has found, based on last year's observations, that the boys become more invested in their work if they choose what math concepts they want to work on and what reading books their group will read. The boys spoke highly of their garden community service project at the Voc Center and their Signing Club, which has provided them with a secret mode of

Fig 2: Test Scores

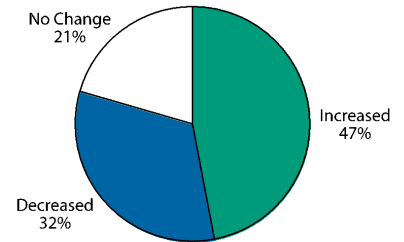

Eight boys and eight girls achieved higher test scores while in single-sex classrooms.

communication (about girls).

The boys don't miss the "distraction" of girl talk, though they admit that they themselves do "way more talking" without the girls around. They say they are glad not to be drawn into the "drama" of girls, who can have "two sides to their personality."

On the other hand, they wouldn't want single-sex classes next year at the junior high school where there is no recess or coed physical education (which Willard offers), because they would "miss friends who are girls."

Do the girls miss anything that having boys in class provides? Entertainment value, it would seem: "Funny jokes." "Acting cool." "Hearing boys complain (as in): 'This is boring...when's lunch?'" (Apparently girls are more likely to whine (as in): "My hair is so messed up.")

Soon the Sanford school board must decide if this experiment will be extended to Year Three. The Year Two students and teachers seem pretty much unanimous in their approval. Chuck Potter would love to develop a fifth grade and fourth grade cohort as well. The girls are okay with that. The guys have some reservations about an all boys fourth grade class: Too boisterous. "Fourth graders aren't mature enough. The teacher couldn't handle it."

Good luck, Chuck. 🌍



PO Box 728
Parsonsfield, ME 04047
meepnews.org

PRSR STD
U.S. POSTAGE
PAID
Permit No. 8
AUGUSTA
MAINE

Return Service Requested

NEW Community-Based Learning Opportunities

Wanted: Student teams and community groups interested in promoting energy efficiency in local households.

Tools, support, and resources (including www.myenergyplan.net) can be provided by DEP, MEEP, local Green Sneakers teams, and the New England Carbon Challenge.

Learn how to help your community by contacting debbie.j.avalone-king@maine.gov

